

Bits Wall

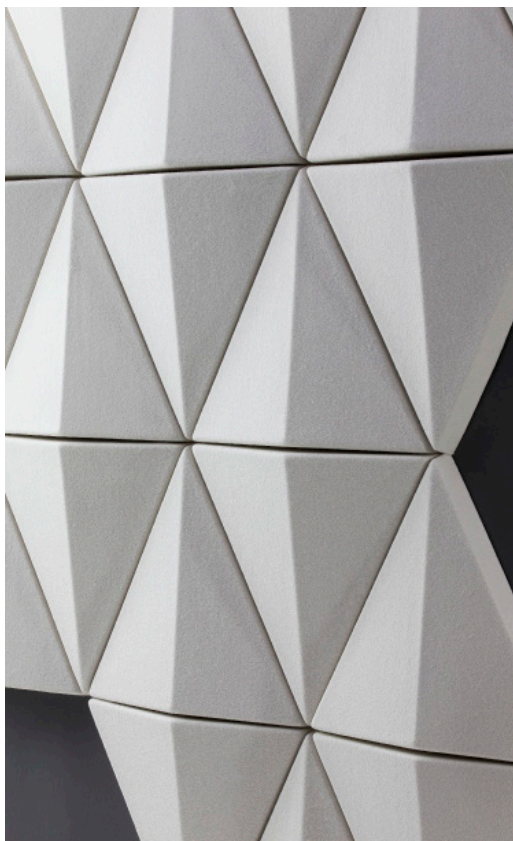



Bits Wall

Design Anya Sebton



Den triangulära formen på Bits Wall ger inte bara ett estetiskt tilltalande uttryck, utan bryter också effektivt ljudvågor, vilket skapar en bättre ljudmiljö.

Using a triangular shape not only produces an aesthetically attractive look, but also effectively breaks the sound waves, which makes a better acoustic environment.

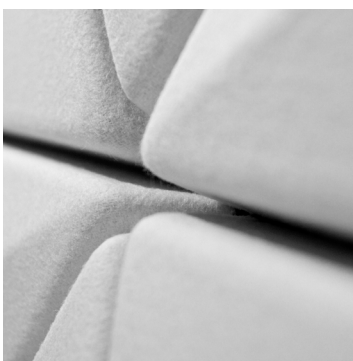

Den ljudabsorberande panelen är tillverkad av polyesterfiber och täckt med tyg.

The sound absorbent panel is made from moulded polyester fibre and covered with fabric.

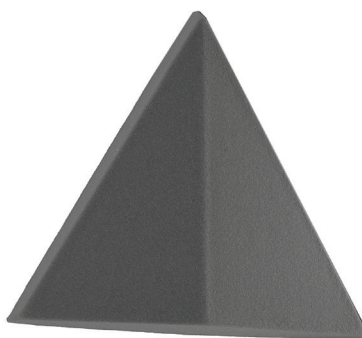

Produkten monteras med dolda hängande beslag mot vägg, vilket gör att panelen både kan hänga horisontellt och vertikalt.

The product is mounted using concealed hanging rails, allowing the panels to be hung either horizontally or vertically.



Systemets modulära konstruktion gör att Bits Wall kan monteras i precis den storlek som användaren kräver.

The system's modular construction means that Bits Wall can be assembled to whatever size the user requires.



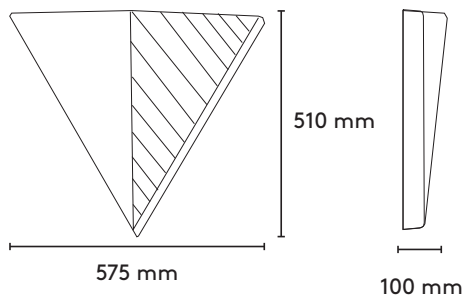

ca 1x1 m = 6 Bits Wall

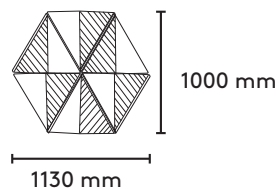

ca 2x2 m = 22 Bits Wall

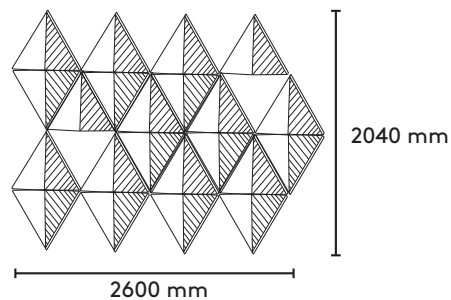

Färgval/Color Choices

Available in other fabrics on request. Please see pricelist.

Camira Blazer



-89
CUZ1N

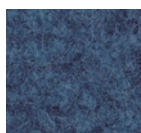

-88
CUZ1W

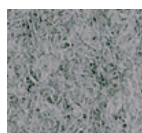

-87
CUZ1E



-85
CUZ33

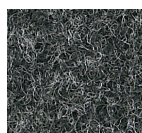

-82
CUZ30

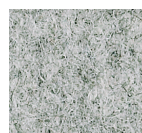

-81
CUZ28

abstracta

info@abstracta.se
www.abstracta.se