

Ecophon Solo™ Freedom

Solo Freedom is a free hanging unit that's possible to design in almost any shape. Create your own unique shapes not found anywhere else or get inspired with Solo Freedom standard shapes; Triangle, Octagon, Heptagon, Hexagon, Pentagon and Ellipse.



Ghalamco Arena, Belgium

SYSTEM RANGE



Size, mm	1039x1200	1040x1200	1139x1198	1168x1198	Ø1200	1200x1200	2400x1000	2400x1200
Special Fixing	•	•	•	•	•	•	•	•
Thickness (THK)	40	40	40	40	40	40	40	40
Inst. Diagr.	M297	M426	M427	M425	M412	M412	M428	M412

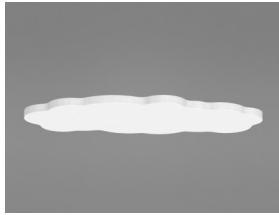

Acoustic panel Solo Freedom in cloud shape

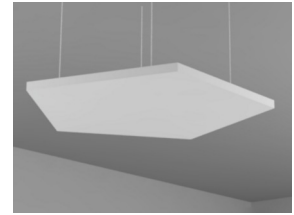
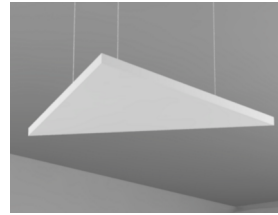
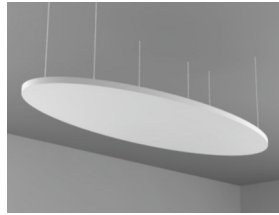

Acoustic



For acoustic data on the panel - please see Solo Square and Rectangle.

Indoor Air Quality



Certificate / Label	Plant	
Eurofins Indoor Air Comfort®	IAC	IAC Gold
French VOC	A	A+
Finnish M1	•	•



Environmental Footprint



	kg CO ₂ equiv/m ²
Solo Freedom	8,41
Solo Freedom/Plant	5,21

Life-cycle stages A1 to C4 from EPD, in conformity with ISO 14025 / EN 15804

Circularity



Minimum post-consumer recycled content	57%
Recyclability	Fully recyclable

Fire safety



Country	Class	
Europe	EN 13501-1	A2-s1,d0

The glass wool core of the tiles is tested and classified as non-combustible according to EN ISO 1182.

Humidity Resistance



Product	
Standard	Class C, RH 95% and 30°C
Plant	Class A, RH 70% and 25°C

According to EN 13964:2014

Visual appearance



White Frost, nearest NCS colour sample S 0500-N, 85% light reflectance. Gloss < 1.

Cleanability



Daily dusting and vacuum cleaning. Weekly wet wiping.



Accessibility

The tiles are demountable.



Installation

Installed according to installation diagrams, installation guides and drawing aid. For information regarding minimum overall depth of system see quantity specification.



Mechanical properties

The tile can take both point loads and distributed loads. See Functional demands, Mechanical properties at www.ecophon.com.



CE

Ecophon ceiling systems are CE marked according to the European harmonized standard EN13964:2014. CE marked construction products are covered by a Declaration of Performance (DOP) which enables customers and users to easily compare performance of products available on the European market.

INSTALLATION DIAGRAM (M412) FOR ECOPHON SOLO FREEDOM

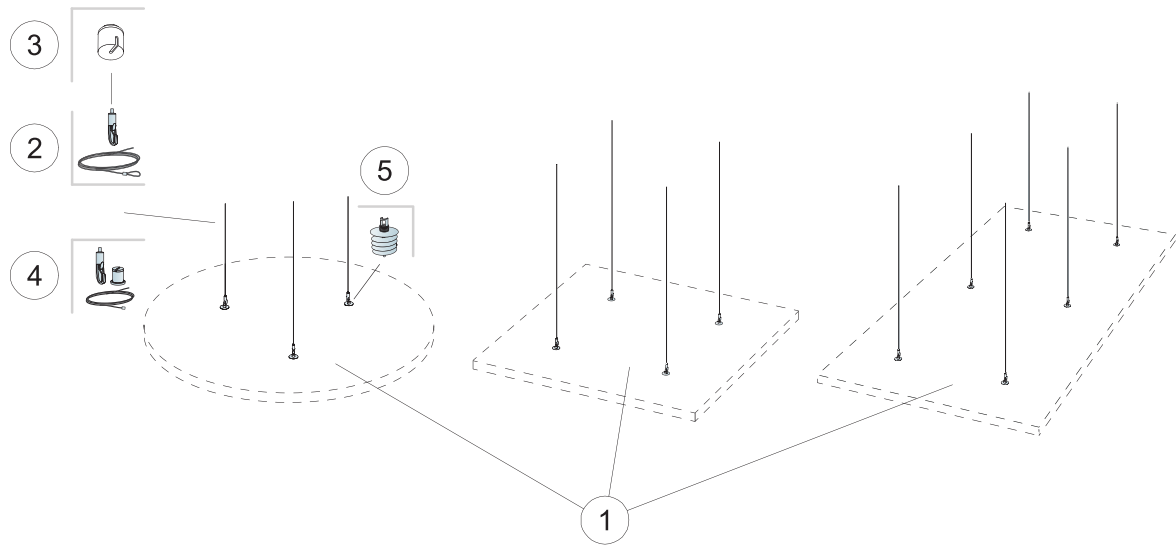

QUANTITY SPECIFICATION (EXCL. WASTAGE)

		Size, mm		
		Ø1200	1200x1200	2400x1200
1	Solo Freedom	as required	as required	as required
2	Connect Adjustable wire hanger	3/panel	4/panel	6/panel
3	Connect Covering cup	3/panel	4/panel	6/panel
4	Connect Adjustable wire kit (Alt 1, Optional)	3/panel	4/panel	6/panel
5	Connect Absorber anchor	3/panel	4/panel	6/panel
Δ Min. overall depth of system: 140 mm		-	-	-

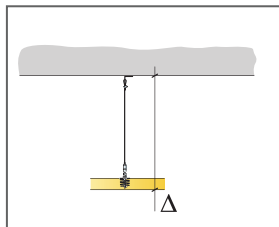

See Quantity specification

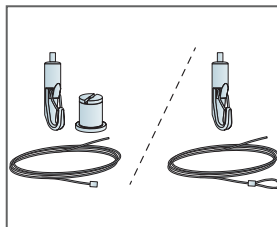

Two types of Adjustable wire solutions

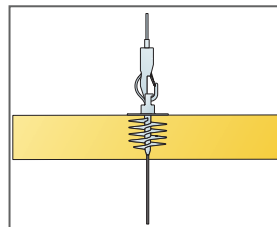

Panels can be suspended underneath each other

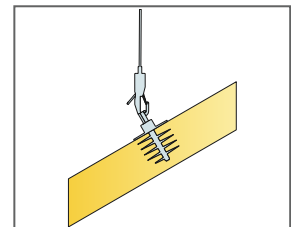

Panels can be installed in angles

INSTALLATION DIAGRAM (M425) FOR ECOPHON SOLO HEPTAGON

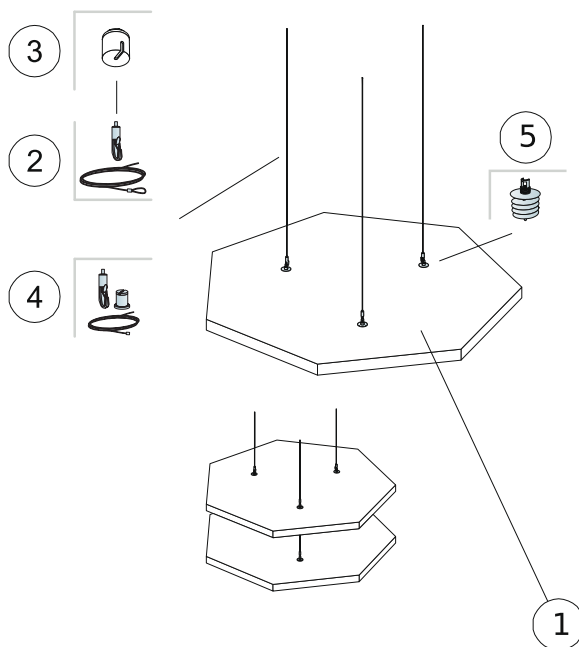

QUANTITY SPECIFICATION (EXCL. WASTAGE)

		Size, mm
		1168x1198
1	Solo Heptagon	1,03m ² /panel
2	Connect Adjustable wire hanger (Alt 1)	3/panel
3	Connect Covering cup (Alt 1, Optional)	3/panel
4	Connect Adjustable wire Kit (Alt 1, Optional)	3/panel
5	Connect Absorber anchor (Alt 1)	3/panel
Δ Min. overall depth of system: 140 mm		-
To install Connect Absorber Anchor, use Connect Absorber Anchor Bit.		-

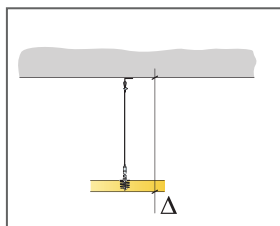

See Quantity specification

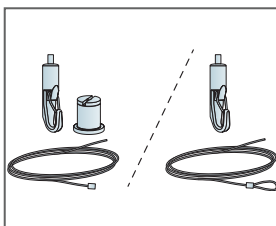

Two types of Adjustable wire solutions

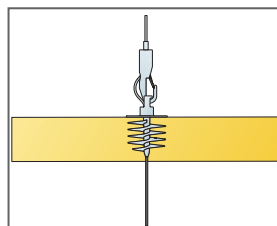

Panels can be suspended underneath each other

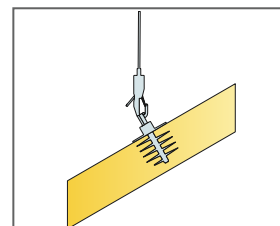

Panels can be installed in angles

INSTALLATION DIAGRAM (M426) FOR ECOPHON SOLO HEXAGON

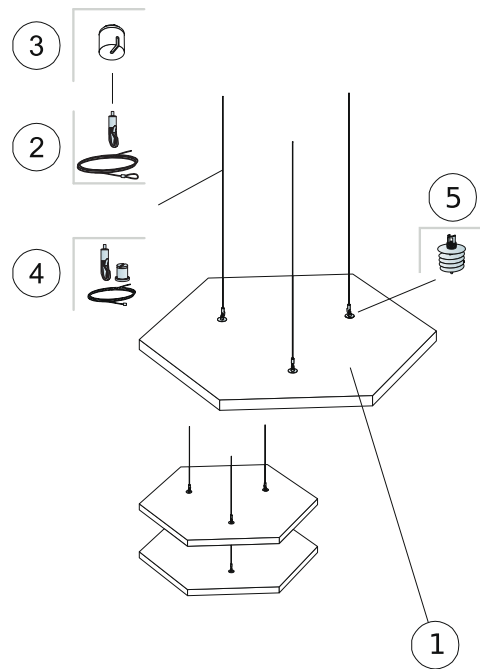

QUANTITY SPECIFICATION [EXCL. WASTAGE]

		Size, mm
		1040x1200
1	Solo Hexagon	0,94m ² /panel
2	Connect Adjustable wire hanger (Alt 1)	3/panel
3	Connect Covering cup (Alt 1, Optional)	3/panel
4	Connect Adjustable wire Kit (Alt 1, Optional)	3/panel
5	Connect Absorber anchor (Alt 1)	3/panel
Δ Min. overall depth of system: 140 mm		-
To install Connect Absorber Anchor, use Connect Absorber Anchor Bit.		-

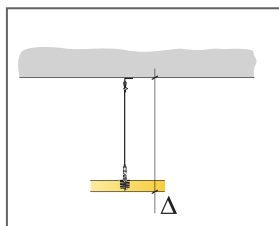

See Quantity specification

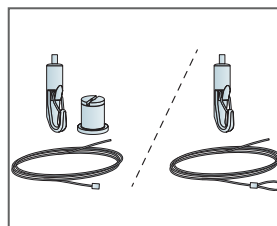

Two types of Adjustable wire solutions

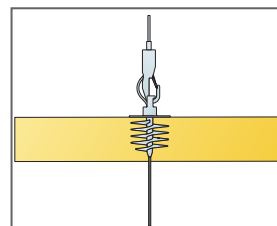

Panels can be suspended underneath each other

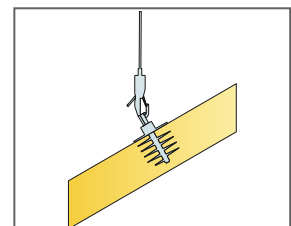

Panels can be installed in angles

INSTALLATION DIAGRAM (M427) FOR ECOPHON SOLO PENTAGON

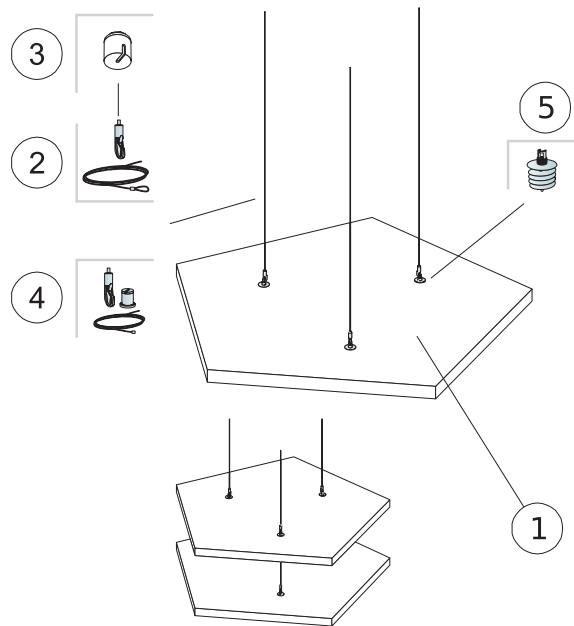

QUANTITY SPECIFICATION (EXCL. WASTAGE)

		Size, mm
		1139x1198
1	Solo Pentagon	0,94m ² /panel
2	Connect Adjustable wire hanger (Alt 1)	3/panel
3	Connect Covering cup (Alt 1, Optional)	3/panel
4	Connect Adjustable wire Kit (Alt 1, Optional)	3/panel
5	Connect Absorber anchor (Alt 1)	3/panel
Δ Min. overall depth of system: 140 mm		-
To install Connect Absorber Anchor, use Connect Absorber Anchor Bit.		-

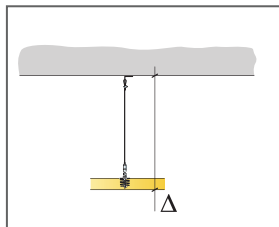

See Quantity specification

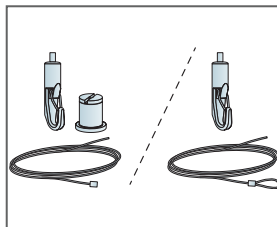

Two types of Adjustable wire solutions

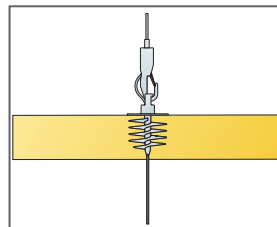

Panels can be suspended underneath each other

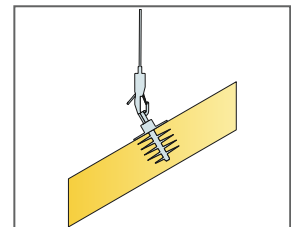

Panels can be installed in angles

INSTALLATION DIAGRAM (M428) FOR ECOPHON SOLO ELLIPSE

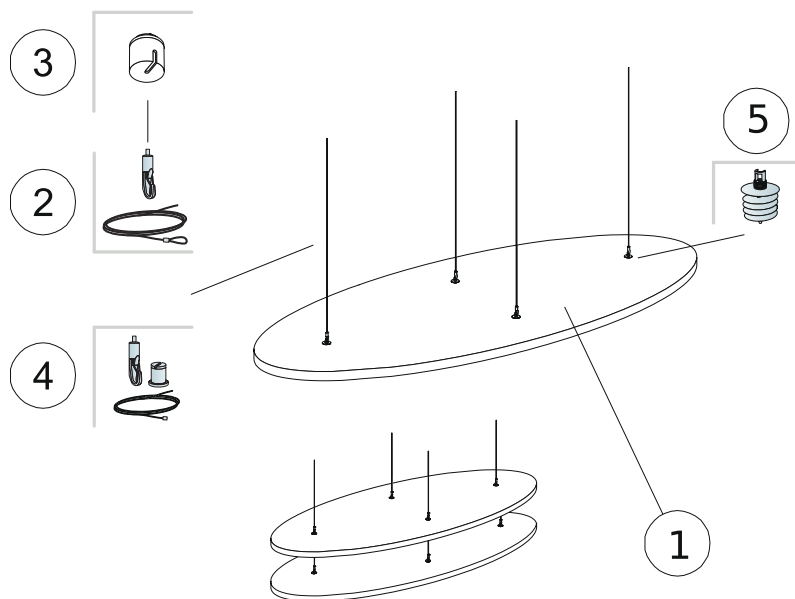

QUANTITY SPECIFICATION (EXCL. WASTAGE)

		Size, mm
		2400x1000
1	Solo Ellipse	1,89m ² /panel
2	Connect Adjustable wire hanger (Alt 1)	4/panel
3	Connect Covering cup (Alt 1, Optional)	4/panel
4	Connect Adjustable wire kit (Alt 1, Optional)	4/panel
5	Connect Absorber anchor (Alt 1)	4/panel
Δ Min. overall depth of system: 140 mm		-
To install Connect Absorber Anchor, use Connect Absorber Anchor Bit.		-

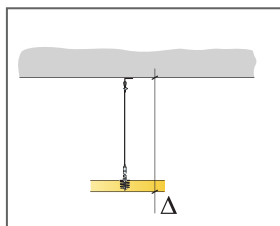

See Quantity specification

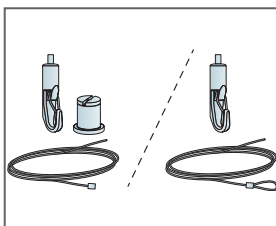

Two types of Adjustable wire solutions

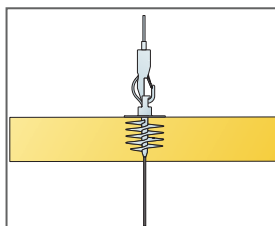

Panels can be suspended underneath each other

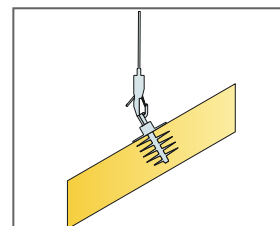

Panels can be installed in angles

INSTALLATION DIAGRAM (M297) FOR ECOPHON SOLO TRIANGLE

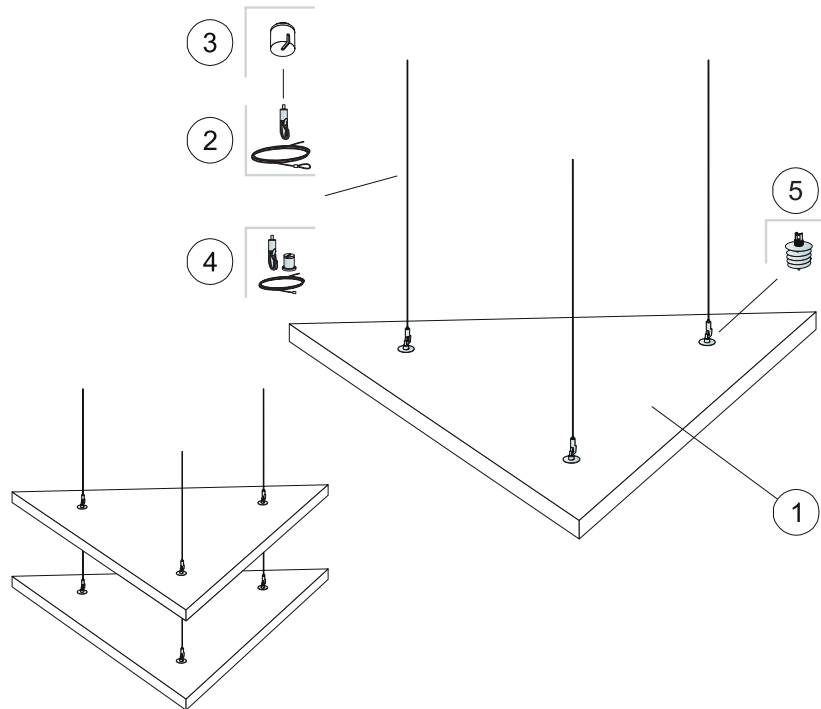

QUANTITY SPECIFICATION (EXCL. WASTAGE)

		Size, mm
		1039x1200
1	Solo Triangle	0,62m ² /panel
2	Connect Adjustable wire hanger	3/panel
3	Connect Covering cup (Alt 1, Optional)	3/panel
4	Connect Adjustable wire Kit (Alt 1, Optional)	3/panel
5	Connect Absorber anchor	3/panel
Δ Min. overall depth of system: 140 mm		-
To install Connect Absorber Anchor, use Connect Absorber Anchor Bit.		-

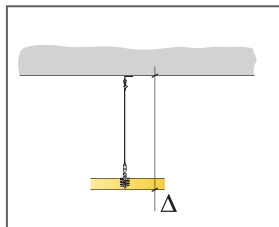

See Quantity specification

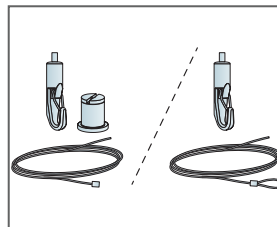

Two types of Adjustable wire solutions

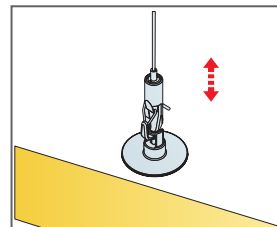

Easily adjustable suspension with Connect Adjustable wire hanger

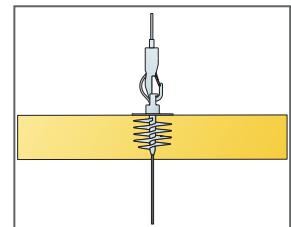

Panels can be suspended underneath each other